

Safedge™ Profiles

Description

The ability of the Safedge profile to out perform competition lies in its innovative design. It uses a combination of non-conductive rubber and flexible wire-cored conductive rubber bonded together so it keeps bouncing back into shape even after repeated compressions.



The Safedge profiles come in three different cushion factors: 5 mm (0.2 in.), 19 mm (0.75 in.), and 41 mm (1.6 in.). Cushion factor is the distance the profile can be depressed after a signal has been generated. The profiles are also offered with a sealing lip which is designed to reduce drafts between the profile and opposing surface.

The profiles come in two different materials. Use the EPDM material in the presence of conductive fluids. The NBR/CR material performs better in the presence of oils. Review the chemical resistance chart to help make the best choice of material. If in doubt, a small sample of the profile should be tested for chemical resistance before a final selection is made.

The Safedge profile has no rigid internal parts which can “break through” or cause fatigue failures after prolonged use. The multi-stranded copper wire core throughout the length of the strip reduces the risk of resistance build up on long lengths.

Features

- Various profiles
- Conductive rubber technology
- Up to 50 m lengths
- Aluminum, plastic or zinc-coated steel mounting rails
- Rubber boot optional
- Active corners
- Sealing lip available

Specifications

Standards	EN1760-2, EN 954-1, ISO13849-1, IEC/EN60204-1, ANSI B11.19, AS 4024.5
Certifications	CE Marked for all applicable directives and TÜV. C-Tick not required.
Power Supply	Operates on 4V DC supplied from control unit.
Operating Temperature [C (F)]	EPDM material: -5...55° (23...131°) NBR/CR material: 0...55° (32...131°)
Relative Humidity	90%
Enclosure Type Rating	IP65 (NEMA 6P)
Wire Size	18 AWG
Material	EPDM: Ethylene Propylene Diene Modified Rubber NBR/CR: Acrylonitrile (34% nitrile) Butadiene Rubber/Chloroprene Rubber
Bend Radius, Min.	500 mm (19.6 in.)



Chemical Resistance of Safedge Profile

Substance	Resistance—"S" Profile EPDM	Resistance—"N" Profile NBR/CR
Acetic Acid (10%)	Good	Good
Acetone	Good	Fair
Ammonium Hydroxide (35%)	Good	Good
Benzene	Poor	Poor
Diesel Oil	Poor	Good
Ethyl Alcohol (Ethanol)	Good	Good
Hydrochloric Acid (10%)	Good	Good
Lubricating Oil	Poor	Good
Nitric Acid (10%)	Good	Fair
Petrol (Gasoline)	Poor	Fair
Silicone Fluids	Good	Good
Sodium Chloride (25%)	Good	Good
Trichlorethylene	Good	Poor
Vegetable Oils (general)	Good	Good
Water (distilled)	Good	Good
Water (sea)	Good	Good
Latex Paint	Good	Good
Oil Base Paint	Good (easy to clean)	

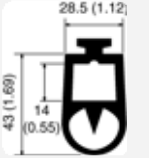
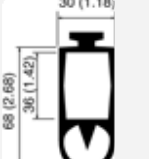
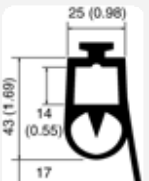
Product Selection—Profiles



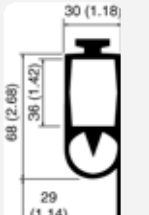

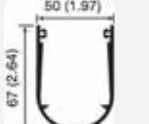



Code (See Factory Assembled Product Selection)	Approx. Dimensions [mm (in.)]	Safedge Profile	Description	Cushion Factor	Length [m (ft)]	Cat. No.
A		0110S	Black, EPDM, Weight: 463 g/m (0.33 lbs/ft)	5 mm (0.20 in.)	5 (16.4)	440F-E0110S05
					10 (32.8)	440F-E0110S10
					20 (65.6)	440F-E0110S20
C		0110N	Black, NBR/CR, Weight: 460 g/m (0.31 lbs/ft)	5 mm (0.20 in.)	5 (16.4)	440F-E0110N05
					10 (32.8)	440F-E0110N10
					20 (65.6)	440F-E0110N20
B		0110R	Red, EPDM, Weight: 502 g/m (0.34 lbs/ft)	5 mm (0.20 in.)	5 (16.4)	440F-E0110R05
					10 (32.8)	440F-E0110R10
					20 (65.6)	440F-E0110R20
E		1610S	Black, EPDM, Weight: 843 g/m (0.57 lbs/ft)	19 mm (0.75 in.)	5 (16.4)	440F-E1610S05
					10 (32.8)	440F-E1610S10
					20 (65.6)	440F-E1610S20
F		1610N	Black, NBR/CR, Weight: 837 g/m (0.56 lbs/ft)	19 mm (0.75 in.)	5 (16.4)	440F-E1610N05
					10 (32.8)	440F-E1610N10
					20 (65.6)	440F-E1610N20
H		0310S	Black, EPDM, Weight: 1209 g/m (0.81 lbs/ft)	41 mm (1.61 in.)	5 (16.4)	440F-E0310S05
					10 (32.8)	440F-E0310S10
					20 (65.6)	440F-E0310S20
D, J		0510S	Black, EPDM, with Sealing Lip, Weight: 545 g/m (0.37 lbs/ft)	5 mm (0.20 in.)	5 (16.4)	440F-E0510S05
					10 (32.8)	440F-E0510S10
					20 (65.6)	440F-E0510S20
G, K		0804S	Black, EPDM, with Sealing Lip, Weight: 1013 g/m (0.68 lbs/ft)	19 mm (0.75 in.)	5 (16.4)	440F-E0804S05
					10 (32.8)	440F-E0804S10
					20 (65.6)	440F-E0804S20

Note: Maximum roll size before axial connector needed is 20 m (65.6 ft).

Code (See Factory Assembled Product Selection)	Approx. Dimensions [mm (in.)]	Safedge Profile	Description	Cushion Factor	Length [m (ft)]	Cat. No.
I, L		0210S	Black, EPDM, with Sealing Lip, Weight: 1291 g/m (0.87 lbs/ft)	41 mm (1.61 in.)	5 (16.4)	440F-E0210S05
					10 (32.8)	440F-E0210S10
					20 (65.6)	440F-E0210S20
M		0118S	Black, EPDM, Weight: 242 g/m (0.163 lbs/ft) (mini profile)	3.75 mm (0.15 in.)	5 (16.4)	440F-E0118S05
					10 (32.8)	440F-E0118S10
					20 (65.6)	440F-E0118S20
N, O		1111S	Black, EPDM, Weight: 680 g/m (0.457 lbs/ft)	NA	5 (16.4)	440F-E1111S05
					10 (32.8)	440F-E1111S10
					20 (65.6)	440F-E1111S20

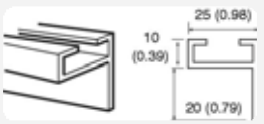





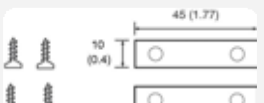

Note: Maximum roll size before axial connector needed is 20 m (65.6 ft).

Product Selection—C-Rails









Code	Approx. Dimension [mm (in.)]	Description	Cat. No.
A		Aluminium type, Type C112/A. Suitable for all profiles. Length: 3 m (9.8 ft) Weight: 258 g/m (0.17 lbs/ft)	440F-R1212
B		Zinc-Coated Steel; Type C112/S. Suitable for all profiles. Length: 2 m (6.5 ft) Weight: 663 g/m (0.45 lbs/ft)	440F-R1112
C		PVC Black; Type C112/PB. Suitable for all profiles. Length: 3 m (9.8 ft) Weight: 111 g/m (0.07 lbs/ft)	440F-R1212PB
D		PVC Red; Type C112/PR. Suitable for all profiles. Length: 3 m (9.8 ft) Weight: 111 g/m (0.07 lbs/ft)	440F-R1212PR
E		PVC Yellow; Type C112/PY. Suitable for all profiles. Length: 3 m (9.8 ft) Weight: 111 g/m (0.07 lbs/ft)	440F-R1212PY
F		Aluminium Vertical Lip; Type C112/A2. Suitable for all profiles. Length: 2 m (6.5 ft) Weight: 368 g/m (0.25 lbs/ft)	440F-R1214
G		Aluminium Horizontal Lip; Type C112/A3. Suitable for all profiles. Length: 2 m (6.5 ft) Weight: 388 g/m (0.26 lbs/ft)	440F-R1215
H		Aluminium Deep Channel; Type C112/A4. Suitable for all profiles. Length: 2 m (6.5 ft) Weight: 345 g/m (0.23 lbs/ft)	440F-R1216
I		Aluminium; Suitable for Mini Profile Only. Length: 2 m (6.5 ft) Weight: 150 g/m (0.10 lbs/ft)	440F-R1219

Code	Approx. Dimension [mm (in.)]	Description	Cat. No.
J		Aluminium; Suitable for Rubber Boot Only. Length: 2 m (6.5 ft) Weight: 667 g/m (0.448 lbs/ft)	440F-R2151
NA		Aluminium End Plate for C-Rail Option J; 2 Plates; 4 Screws, flat head Philips, 10mm, #6 Weight: 7g (0.01 lbs)	440F-R2152

Product Selection—Component Parts

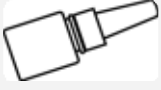
Description	Product Selection Criteria		Cat. No.
	Connector and Cable (diameter = 5 mm (0.20 in.))	1 m (3.2 ft)	440F-A1301
		2 m (6.56 ft)	440F-A1302
		5 m (16.4 ft)	440F-A1305
		10 m (32.8 ft)	440F-A1306
		15 m (49.2 ft)	440F-A1307
	Terminator	6 kΩ (yellow) resistor for series termination	440F-A1308
		15 kΩ (blue) for parallel termination	440F-A1309
	Closing Cap for profile codes (A, B, C, D, J)	Closing Cap material: EPDM	440F-A1302S
		Closing Cap material: NRB	440F-A1302N
	Closing Cap for profile codes (E, F, G, H, K)	Used to close profiles 440F-E0310S and 440F-E1610S.	440F-A1303S
		Used to close profile 440F-E1610N.	440F-A1303N
	Axial Connector	With this connector you can directly connect two profiles. Suitable for 440F-E0110S profiles.	440F-A0061S
		With this connector you can directly connect two profiles. Suitable for 440F-E0110R profiles.	440F-A0061N
	Straight Pin Connector	Kit contains one pair of pins suitable for one joint.	440F-A0004
	90° Corner Connector	For use with profile 440F-E0110S	440F-A0071S
		For use with profile 440F-E0110R	440F-A0071S
		For use with profile 440F-E0110N	440F-A0071N
		For use with profile 440F-E0310S	440F-A0073S
		For use with profile 440F-E1610S	440F-A0074S
		For use with profile 440F-E1610N	440F-A0074N
	90° Corner Connector (vertical)	For use with profile 440F-E0110N	440F-A0072N
		For use with profile 440F-E0110S or 440F-E0110R	440F-A0072S
		For use with profile 440F-E1610N	440F-A0075N
		For use with profile 440F-E1610S	440F-A0075S
		For use with profile 440F-E0310S	440F-A0076S
	45° Corner Connector	For use with profile 440F-E0110N	440F-A0071N45 *

* Includes two rubber strips (440F-A0005) when using profile 440F-E0110N.

Description	Product Selection Criteria		Cat. No.
	60° Corner Connector	When using profile 440F-E0110N	440F-A0071N60 *
	30° Corner Connector	When using profile 440F-E0110N	440F-A24007130 *
	Connector and Cable	Use only on Mini Profile—1 m (3.3 ft)	440F-A1181
		Use only on Mini Profile—3 m (9.8 ft)	440F-A1183
		Use only on Mini Profile—5 m (16 ft)	440F-A1185
	Terminator	Use only on Mini Profile—8 kΩ (yellow) resistor for series termination	440F-A1186
	Closing Cap	Use only on Mini Profile—Closing Cap material: EPDM	440F-A1318
	Cyanocrylate Adhesive	Use Loctite 401 for dry applications. Use Loctite 380E for wet applications.	NA
	Shears	Use to cut profiles.	440F-A3084
	Connection Box	Polycarbonate housing 53 x 53 x 35 mm (2.09 x 2.09 x 1.38 in.) complete with two pole terminal and trumpet type screw on connector with strain and relief clamp. For use with coiled cable.	440F-A0116
	Coiled Connection Cable	2.5 m (8.2 ft) (extended) of flexible coiled cable. Shelf length is 889 mm (35 in.) long. OD of coil is 22 mm (0.86 in.) and OD of cable is 5 mm (0.20 in.).	440F-A2450
		3.5 m (11.5 ft) (extended) of flexible coiled cable. Shelf length is 1270 mm (50 in.) long. OD of coil is 22 mm (0.86 in.) and OD of cable is 5 mm (0.20 in.).	440F-A2700
	Two rubber strips	When using profile 440F-E0110N shelf length is 175 x 10 x 0.7 mm (6.89 x 0.39 x 0.03 in.).	440F-A0005

* Includes two rubber strips (440F-A0005) when using profile 440F-E0110N.

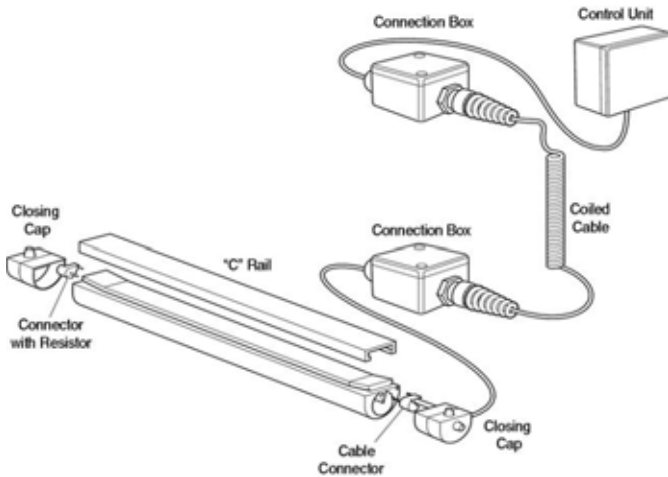

Example application of profile using coiled cable. The coiled cable can not be directly connected to the profile due to the weight of the cable. The proper use of the coiled cable is to connect the coiled cable to the profile through the connection box. The coiled cable should be secured to both the moving and stationary objects so as to prevent straining of the terminal connections.

Factory Assembled Product Selection (standard profile)

440F - E★ C A M V 01270
a b c d e

a	
Profile	
Code	Description
A	0110S
B	0110R
C	0110N
D	0510S with Sealing Lip on Right Side
E	1610S
F	1610N
G	0804S with Sealing Lip on Right Side
H	0310S
I	0210S with Sealing Lip on Right Side
J	0510S with Sealing Lip on Left Side
K	0804S with Sealing Lip on Left Side
L	0210S with Sealing Lip on Left Side
N	Rubber Boot over 0110S
O	Rubber Boot over 1610S
P	No Profile

b	
C-Rail	
Code	Description
A	1212 aluminium for profile codes A-L
B	1112 zinc coated steel for profile codes A-L
C	1212PB PVC black for profile codes A-L
D	1212PR PVC red for profile codes A-L
E	1212PY PVC yellow for profile codes A-L
F	1214 aluminium with vertical lip for profile codes A-L
G	1215 aluminium with horizontal lip for profile codes A-L
H	1216 aluminium deep rail for profile codes A-L
J	2151 aluminium for profile codes N and O
N	No C-Rail (not needed)

c	
Cable Entrance	
Code	Description
A	LHT left entrance with 1 m cable
B	LHT left entrance with 2 m cable
C	LHT left entrance with 3 m cable
D	LHT left entrance with 5 m cable
E	LHT left entrance with 10 m cable
F	RHT right entrance with 1 m cable
G	RHT right entrance with 2 m cable
H	RHT right entrance with 3 m cable
I	RHT right entrance with 5 m cable
J	RHT right entrance with 10 m cable
K	SET straight entrance with 1 m cable
L	SET straight entrance with 2 m cable
M	SET straight entrance with 3 m cable
N	SET straight entrance with 5 m cable
O	SET straight entrance with 10 m cable
P	UNDER entrance with 1 m cable
Q	UNDER entrance with 2 m cable
R	UNDER entrance with 3 m cable
S	UNDER entrance with 5 m cable
T	UNDER entrance with 10 m cable
U	No entrance components

d	
Termination	
Code	Description
A	LHT left exit with 1 m cable
B	LHT left exit with 2 m cable
C	LHT left exit with 3 m cable
D	LHT left exit with 5 m cable
E	LHT left exit with 10 m cable
F	RHT right exit with 1 m cable
G	RHT right exit with 2 m cable
H	RHT right exit with 3 m cable
I	RHT right exit with 5 m cable
J	RHT right exit with 10 m cable
K	SET straight exit with 1 m cable
L	SET straight exit with 2 m cable
M	SET straight exit with 3 m cable
N	SET straight exit with 5 m cable
O	SET straight exit with 10 m cable
P	UNDER exit with 1 m cable
Q	UNDER exit with 2 m cable
R	UNDER exit with 3 m cable
S	UNDER exit with 5 m cable
T	UNDER exit with 10 m cable
U	Parallel Termination—15 k Ω
V	Series Termination—6 k Ω
W	No exit components

e	
Length of Edge	
Code	Description
5 digit number	Enter length of edge in mm; for example: 50 m = 50000, 500 mm = 00500; 300 mm minimum; \pm 2.5 mm tolerance

* Order Controller separately. Refer to SafeEdge Controllers product selection on Product Selection—Relays.

Factory Assembled Product Selection (mini-profile)



440F - E* **M** **I** **M** **V** **01270**
 a b c d e

a	
Profile	
Code	Description
M	0118S 3.75 mm (0.15 in.) Cushion Factor Black, Mini Profile
P	No Profile

b	
C-Rail	
Code	Description
I	1219 aluminium for "Profile" code M
N	No C-Rail (not needed)

c	
Cable Entrance	
Code	Description
K	SET straight entrance 1 m cable
M	SET straight entrance 3 m cable
N	SET straight entrance 5 m cable
P	UNDER entrance 1 m cable
R	UNDER entrance 3 m cable
S	UNDER entrance 5 m cable
U	No entrance components

d	
Termination	
Code	Description
K	SET straight entrance 1 m cable
M	SET straight entrance 3 m cable
N	SET straight entrance 5 m cable
P	UNDER entrance 1 m cable
R	UNDER entrance 3 m cable
S	UNDER entrance 5 m cable
V	Series Termination—8 kΩ
W	No Termination

e	
Length of Edge	
Code	Description
5 digit number	Enter length of edge in mm; for example: 50 m = 50000, 500 mm = 00500; 300 mm minimum; ± 2.58 mm tolerance

* Order Controller separately. Refer to SafeEdge Controllers product selection.

Factory Assembled Examples

440F-ECAKV01250

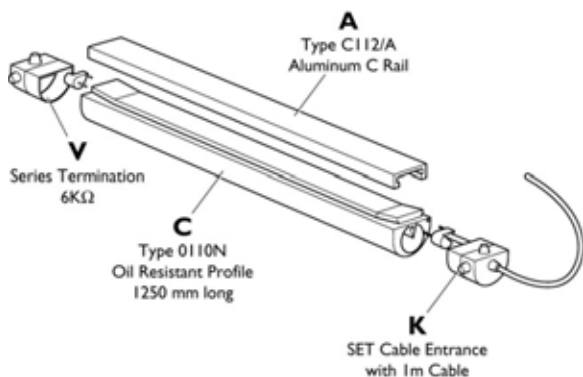

This is a single oil resistant profile which is 1250 mm (49.2 in.) long. The edge is terminated with a Series Termination. A 1 m (3.2 ft) cable enters straight into the closing cap. The profile is mounted on a standard aluminum C-rail.

440F-EDFHV00490

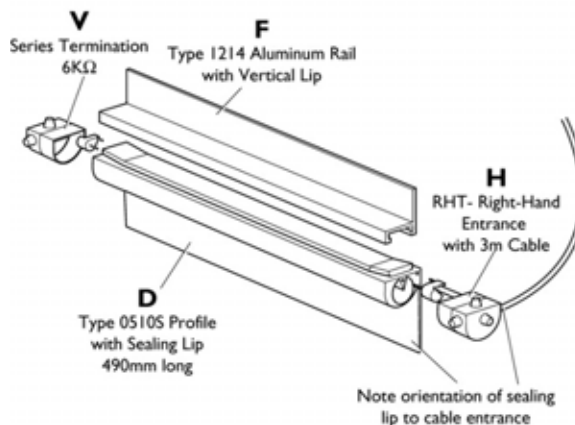

This single profile has a sealing lip and is 490 mm (19.2 in.) long. The profile is terminated with a Series Termination. A 3 m (9.8 ft) cable enters into the right hand side of the closing cap from a plastic surface mounted controller. The profile is mounted on an aluminum rail with a vertical lip for ease of mounting. The orientation of the sealing lip to the vertical lip can be reversed by the user by sliding the profile out of the C-rail, rotating the C-rail 180° and then re-inserting the profile back into the C-rail.

440F-ECFGD01250

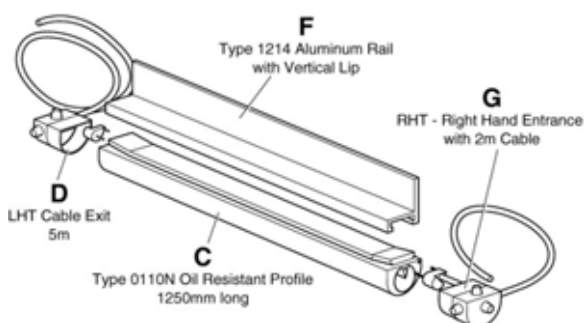

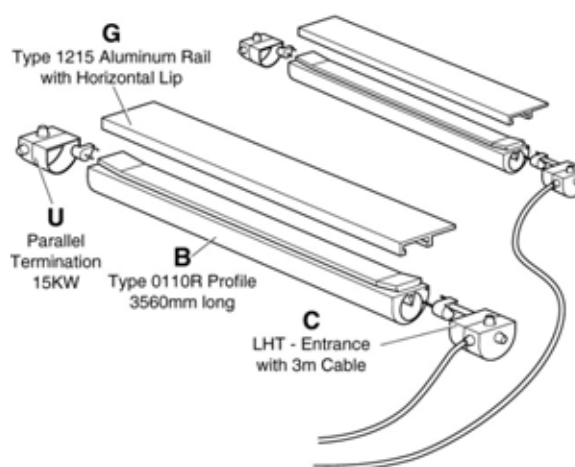

This is a single oil resistant profile which is 1250 mm (49.2 in.) long. The edge is terminated with a 1 m (3.2 ft) cable. A 1 m cable enters straight into the closing cap. The profile is mounted on an aluminum C-rail with a vertical mounting lip. A control unit is not included. This edge is intended to be used in series with another length of edge which has a terminating resistor.

440F-EBGCU03560



This is a red-colored single profile which is 3560 mm (140.15 in.) long. This profile is part of a parallel profile system, for ease of mounting, as it is terminated with a Parallel Termination. A 3 m (9.8 ft) cable enters into the left side of the closing cap. The profile is mounted on an aluminum C-rail with a horizontal lip for ease of mounting. The horizontal lip can be reversed by the user by sliding the profile out of the C-rail, rotating the C-rail and then re-inserting the profile back into the C-rail. A separate Cat. No. must be entered for the other profile.

Product Selection—Relays

Single Function Safety Relays	Safety Outputs	Auxiliary Outputs	Terminals	Reset Type	Power Supply	Cat. No.
	2 N.O.	1 N.C.	Fixed	Automatic/Manual	24V AC/DC or 115/230V AC	440F-C251D
	1 N.O.		Removable		24V AC/DC	440F-C252D
	2 N.O.		Fixed		24V AC/DC or 115/230V AC	440F-C251P

Typical Wiring Diagrams

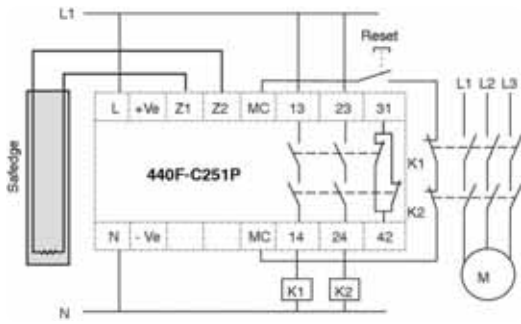

Series Terminated, Safedge Input, Manual Reset, Dual Channel Output, Monitored Output

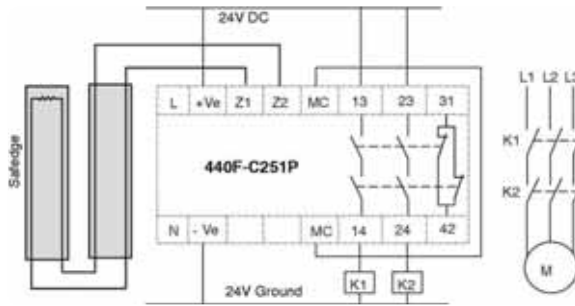

Series Terminated, Cascaded, Safedge Input, Automatic Reset, Dual Channel Output, No Output Monitored

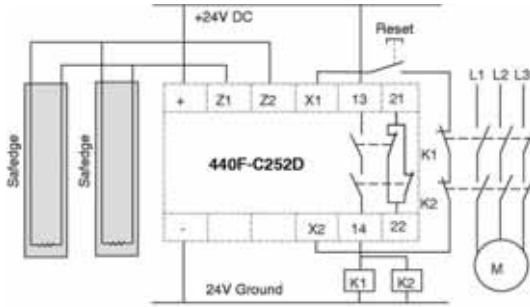

Parallel Terminated, Safedge Input, Manual Reset, Dual Channel Output, Monitored Output

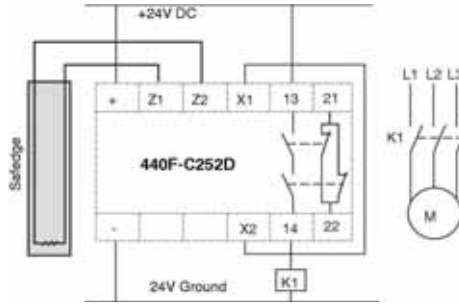

Series Terminated, Safedge Input, Automatic Reset, Single Channel Output, No Output Monitored